

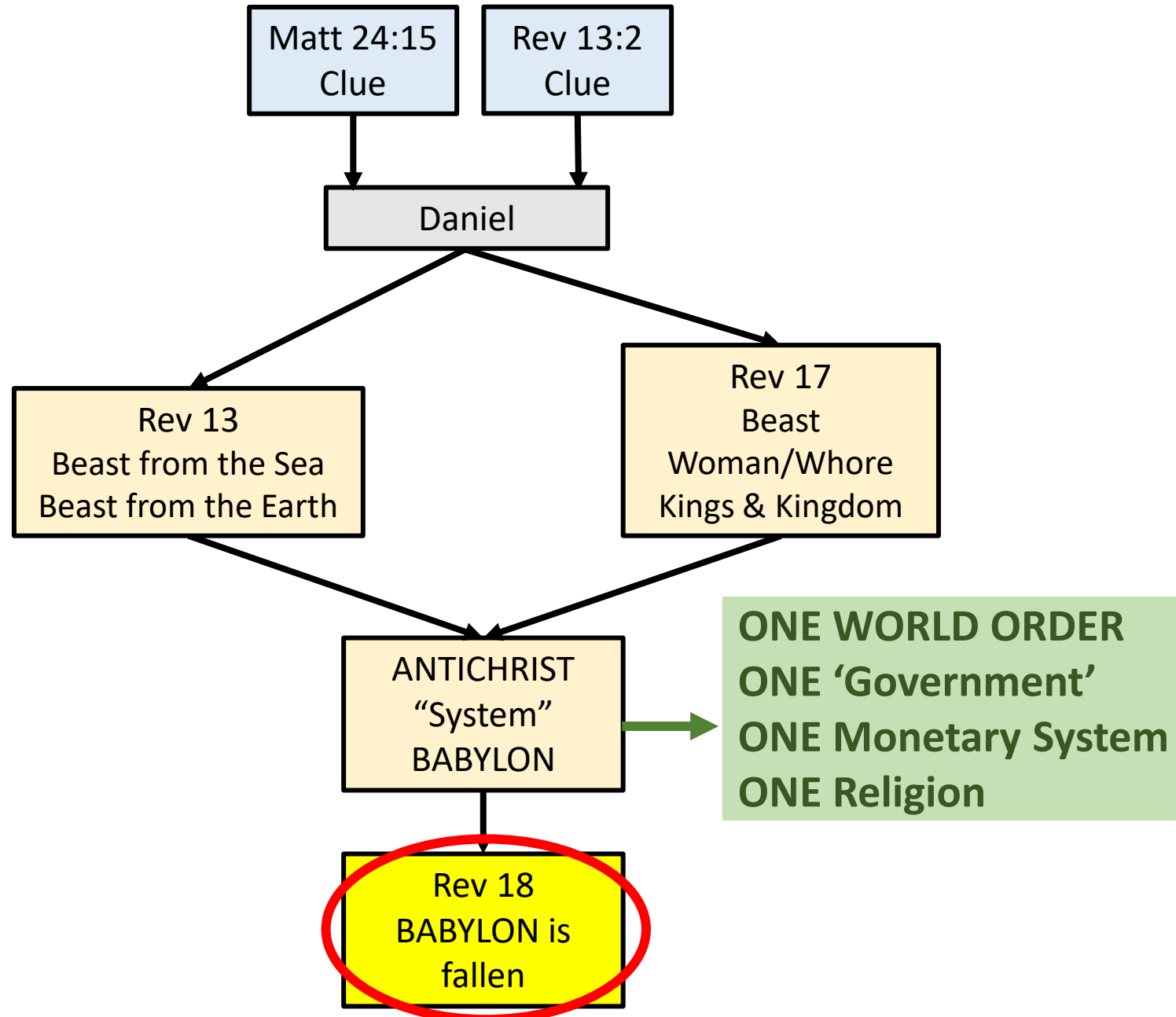

Revelation & End Times Study

SESSION 4D



When will
BABYLON
be remembered by God?

When will
BABYLON
be judged by God?

REVELATION 16:

Rev 16:17-19

17 And the **seventh angel poured out his vial into the air**; and there came a great voice out of the temple of heaven, from the throne, saying, **It is done.**

18 And there were **voices**, and **thunders**, and **lightnings**; and there was a **great earthquake**, such as was not since men were upon the earth, so mighty an earthquake, and so great.

19 And the great city was divided into three parts, and the **cities of the nations fell**: and great **Babylon** came in remembrance before God, to give unto her the cup of the wine of the fierceness of his wrath.

7th Vial

7th Vial
7th angel poured out his vial
into the AIR

7th Vial:

**Voice out of the temple of heaven
From the throne saying:**

'IT IS DONE'

**VOICES, THUNDERS, LIGHTNINGS,
AN EARTHQUAKE
[AND GREAT HAIL (v21)]**

**Great mighty earthquake
(as never before)**

**Great city was divided in 3 parts
Cities of the nations fell**

**Great Babylon remembered by God
Wrath upon Babylon**

THE 7 VIALS

1st Vial: Noisome & grievous sores
EARTH



2nd Vial: **SEA** became blood



3rd Vial: **RIVERS & FOUNTAINS OF WATER**
became blood



4th Vial: **SUN** scorch men with fire
great heat



5th Vial: Beast's Kingdom -> **DARKNESS**
Blasphemed God, pains & sores



6th Vial: River **EUPHRATES** - Water dried up
Gather kings of earth for battle



**GATHERED THEM AT
ARMAGEDDON**

7th Vial:

**VOICES, THUNDERS,
LIGHTNINGS, AN
EARTHQUAKE
[AND GREAT HAIL (v21)]**



'IT IS DONE'

Rev 16

**BABYLON
REMEMBERED BY GOD**

Rev 19 - ARMAGEDDON

REVELATION 16

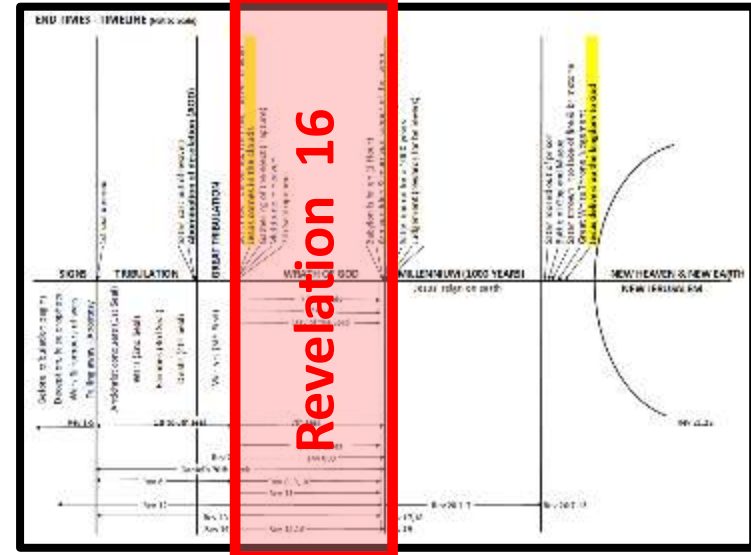
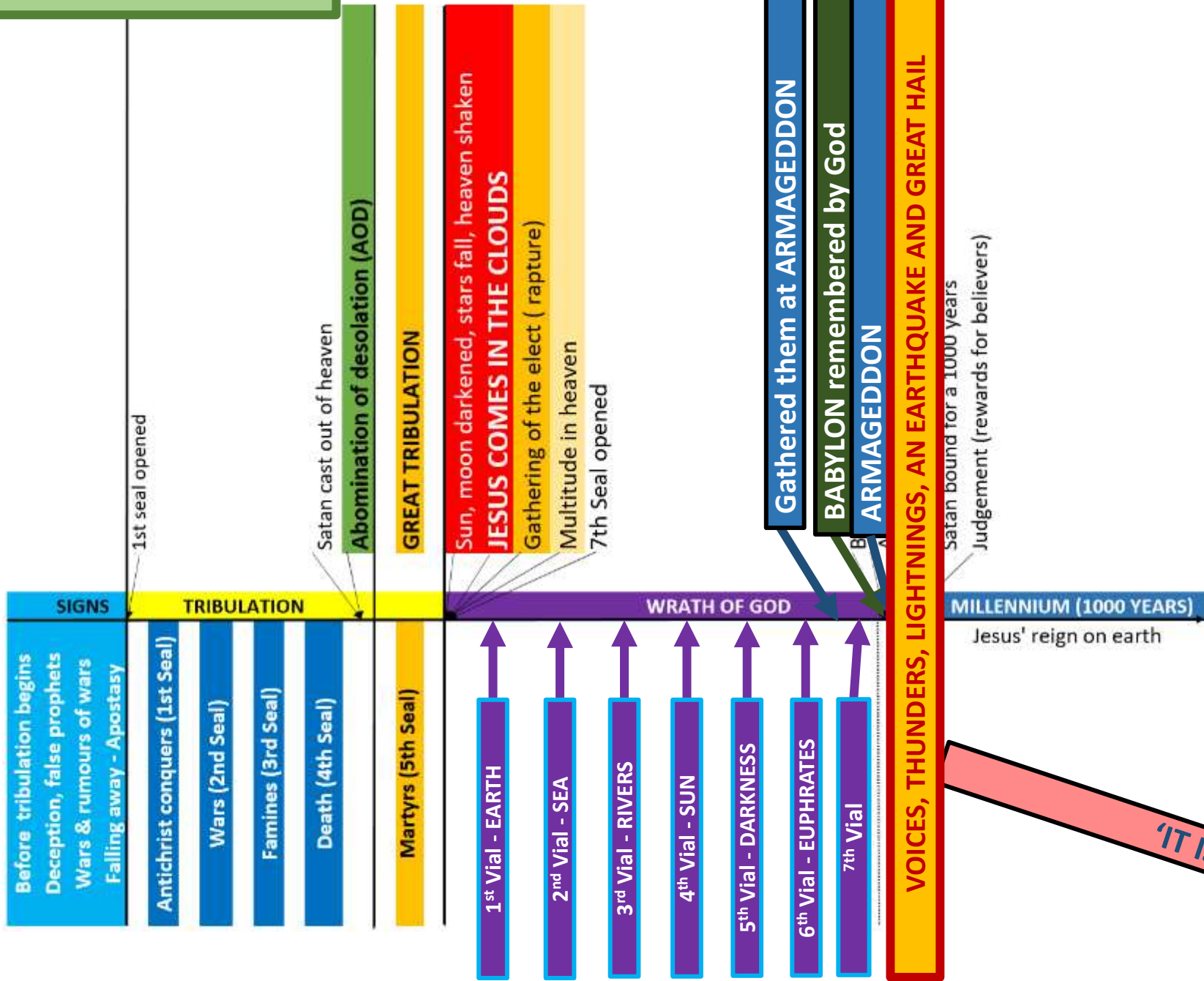

LISTEN / READ

REVELATION 18

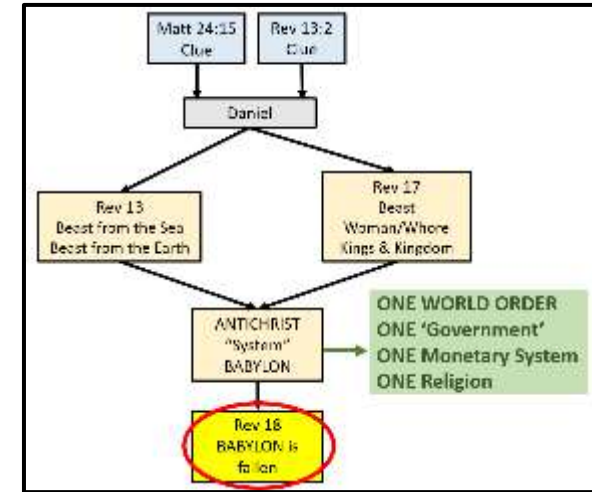

Rev 18:2 “..... Babylon the great is fallen, is fallen”



REVELATION 18:

Rev 18:1-2

1 And after these things I saw **another angel** come down from heaven, having great power; and the earth was lightened with his glory.

2 And he cried mightily with a strong voice, saying,

Babylon the great is fallen, is fallen, and is become the **habitation of devils**, and the hold of every foul spirit, and a cage of every unclean and hateful bird.

JUDGMENT OF BABYLON

Another angel came down from heaven
Having great power
The earth lightened with his glory



Angel cried mightily with a strong voice:

**BABYLON THE GREAT
IS FALLEN, IS FALLEN'**

**"Is become the habitation of devils,
the hold of every foul spirit & a cage
of every unclean and hateful bird"**



Rev 18:2

2 And he cried mightily with a strong voice, saying,
Babylon the great is fallen, is fallen,
and **is become the habitation of devils**, and the hold of every foul spirit, and a
cage of every unclean and hateful bird.

Rev 9:20-21

²⁰ And the rest of the men which were not killed by these plagues yet repented not of the works of their hands, **that they should not worship devils**, and idols of gold, and silver, and brass, and stone, and of wood: which neither can see, nor hear, nor walk: ²¹ Neither repented they of their murders, nor of their sorceries, nor of their fornication, nor of their thefts.

1 Tim 4:1

Now the Spirit speaketh expressly, that in the latter times some shall depart from the faith, **giving heed to seducing spirits, and doctrines of devils**; ² Speaking lies in hypocrisy; having their conscience seared with a hot iron; ³ Forbidding to marry, and commanding to abstain from meats, which God hath created to be received with thanksgiving of them which believe and know the truth.

1 Cor 10:20-21

²⁰ But I say, that the things which the Gentiles sacrifice, **they sacrifice to devils**, and not to God: and **I would not that ye should have fellowship with devils**. ²¹ Ye cannot drink the cup of the Lord, and the cup of devils: ye cannot be partakers of the Lord's table, and of the table of devils.

REVELATION 18:

Rev 18:3

3 For all nations have drunk of the wine of the wrath of **HER** fornication, and the kings of the earth have committed fornication with **HER**, and the merchants of the earth are waxed rich through the abundance of **HER** delicacies.

The kings of the earth have committed fornication with



JUDGMENT OF BABYLON

All nations have drunk the wine of the wrath of **HER** fornication.
The kings of the earth have committed fornication with **HER**.

The merchants of the earth became rich through **HER**.

The merchants of the earth became rich through **HER**



Rev 18:2 Babylon the great is fallen, is fallen

Rev 18:2-3

.....and is become the habitation of devils, and the hold of every foul spirit, and a cage of every unclean and hateful bird. ³ For **all nations have drunk of the wine of the wrath of her fornication**

Rev 14:8

⁸ And there followed another angel, saying, Babylon is fallen, is fallen, that great city, because she made **all nations drink of the wine of the wrath of her fornication.**

**GLOBAL RELIGIOUS SYSTEM
False Religions & Apostate
Christianity**

Rev 18:3

..... **the kings of the earth** have committed fornication with her
....

Rev 17:18

¹⁸ And the woman which thou sawest is that great city, which reigneth over **the kings of the earth.**

**The ANTICHRIST SYSTEM
Global Political /
Governmental System**

Rev 18:3

....., **the merchants of the earth** are waxed rich through the abundance of her delicacies.

Rev 18:19

¹⁹ And they cast dust on their heads, and cried, weeping and wailing, saying, Alas, alas **that great city, wherein were made rich**, all that had ships in the sea by reason of her costliness! for in one hour is she made desolate.

**The ANTICHRIST SYSTEM
Global Economical /
Financial System**

Rev 16:19

19 And the great city was divided into three parts,
and the cities of the nations fell:
and **GREAT BABYLON** came in remembrance before God,
to give unto her the cup of the wine of the fierceness of his wrath.

Rev 16:19 And the great city was divided into **three parts**.....?

Rev 16:19and the cities of the nations fell.....

ONE WORLD

Cities/countries/places from
where **false religions and apostate**
Christianity is promoted?

1

"The A

Cities/countries/places from
where the **world's governmental**
/ political rule is promoted?

2

"The A

Cities/countries/places from
where the **world's economical /**
financial rule is promoted?

3

REVELATION 18:

Rev 18:4-5

4 And I heard another voice from heaven, saying, **Come out of HER, my people, that ye be not partakers of HER sins, and that ye receive not of HER plagues.**

5 For **HER sins have reached unto heaven, and God hath remembered her iniquities.**

JUDGMENT OF BABYLON

**Another voice from heaven:
“Come out of HER, my people,
that ye be not partakers of HER sins,
and that ye receive not of HER
plagues.”**

**HER sins have reached heaven.
God has remembered her iniquities.**

REVELATION 18:

Rev 18:6-7

6 Reward **HER** even as **SHE** rewarded you, and double unto **HER** double according to **HER** works: in the cup which she hath filled fill to **HER** double.

7 How much **SHE** hath glorified herself, and lived deliciously, so much torment and sorrow give **HER**: for **SHE** saith in **HER** heart, I sit a queen, and am no widow, and shall see no sorrow.

John 7:7

⁷The world cannot hate you; but me it hateth, because I testify of it, that **the works thereof are evil**.

JUDGMENT OF BABYLON

SHE will be rewarded, double according to HER works.

**SHE glorified herself.
Lived deliciously.**

SHE says in her heart: 'I sit a queen'

Gal 5:19-21

- ¹⁹ Now **the works of the flesh** are manifest, which are these; Adultery, fornication, uncleanness, lasciviousness,
²⁰ Idolatry, witchcraft, hatred, variance, emulations, wrath, strife, seditions, heresies,
²¹ Envyings, murders, drunkenness, revellings, and such like: of the which I tell you before, as I have also told you in time past, that they which do such things shall not inherit the kingdom of God.

REVELATION 18:

Rev 18:8-9

8 Therefore shall **HER** plagues come in one day, death, and mourning, and famine; and **SHE** shall be utterly burned with fire: for strong is the Lord God who judgeth **HER**.

9 And the kings of the earth, who have committed fornication and lived deliciously with **HER**, shall bewail **HER**, and lament for **HER**, when they shall see the smoke of **HER** burning,



JUDGMENT OF BABYLON

Her plagues shall come in ONE DAY, death, mourning, famine. SHE shall be utterly burnt with fire.



STRONG IS THE LORD GOD WHO JUDGES HER

Kings of earth who have committed fornication and lived deliciously with HER.

They shall wail and lament for HER when they see the smoke of HER burning.

REVELATION 18:

Rev 18:10

10 Standing afar off for the fear of **HER**
torment, saying,
**Alas, alas that great city Babylon, that
mighty city!**
for in **one hour** is thy judgment come.

JUDGMENT OF BABYLON

**'ALAS, ALAS THAT GREAT CITY
BABYLON, THAT MIGHTY CITY!'**

**'in ONE HOUR
is thy judgment come.'**



REVELATION 18:

Rev 18:14

14 And the **fruits** that thy soul lusted after are **departed from thee**, and all things which were dainty and goodly are **departed from thee**, and thou **shalt find them no more at all**.

JUDGMENT OF BABYLON

“fruits that thy soul lusted after”

**departed from thee
shall find them no more at all**

1 John 2:15-16

¹⁵ Love not the world, neither the things that are in the world. If any man love the world, the love of the Father is not in him. ¹⁶ For all that is in the world,
**the lust of the flesh,
and the lust of the eyes,
and the pride of life,**
is not of the Father, but is of the world.

REVELATION 18:

Rev 18:15-16

15 The **merchants of these things**, which were made rich by **HER**, shall stand afar off for the **fear of HER torment, weeping and wailing,**

16 And saying,

Alas, alas that great city, that was clothed in fine linen, and purple, and scarlet, and decked with gold, and precious stones, and pearls!

JUDGMENT OF BABYLON

Merchants of these things made rich by HER shall stand afar off for the fear of HER torment weeping and wailing



ALAS, ALAS THAT GREAT CITY clothed in fine linen, purple, scarlet, decked with gold, precious stones, and pearls.



REVELATION 18:

Rev 18:17-18

17 For in **one hour** so great riches is come to nought. And **every** shipmaster, and **all** the company in ships, and sailors, and as many as trade by sea, stood afar off,

18 And cried when they saw the **smoke of HER burning**, saying,
What city is like unto this great city!

JUDGMENT OF BABYLON

In ONE HOUR
these riches come to nothing.

Every shipmaster, all ship companies, sailors, those that trade by sea stood afar off.

They cried when they saw the smoke of HER burning
'WHAT CITY IS LIKE UNTO THIS GREAT CITY'



REVELATION 18:

Rev 18:19

19 And they cast dust on their heads,
and cried, weeping and wailing, saying,
Alas, alas that great city,
wherein were made rich all that had
ships in the sea by reason of her
costliness! for in **one hour is SHE** made
desolate.

JUDGMENT OF BABYLON

Cast dust on their heads
Cried, weeping and wailing
'ALAS, ALAS THAT GREAT CITY'
made rich all that had
ships in the sea



In ONE HOUR SHE is made desolate

REVELATION 18:

Rev 18:20-21

20 Rejoice over **HER**, thou heaven,
and ye holy apostles and prophets; for
God hath avenged you on **HER**.

21 And a mighty angel took up a stone
like a great millstone, and cast it into
the sea, saying,
Thus with violence shall
that great city Babylon
be thrown down, and shall be found
no more at all.

JUDGMENT OF BABYLON

Rejoice over **HER**,
heaven, apostles and prophets.
God's revenge on **HER**.

An mighty angel
cast millstone
into the sea



“Thus with violence shall
THAT GREAT CITY BABYLON
be thrown down,
and shall be found no more at all.”

REVELATION 18:

Rev 18:22-23a

22 And the **voice** of harpers, and musicians, and of pipers, and trumpeters, shall be **heard no more at all in thee**; and no **craftsman**, of whatsoever craft he be, shall be **found any more in thee**; and the **sound of a millstone shall be heard no more at all in thee**;

23a And the **light of a candle** shall shine no more at all in thee; and the voice of the **bridegroom** and of the **bride shall be heard no more at all in thee**:.....

JUDGMENT OF BABYLON

**No voice (music)
shall be heard no more at all in thee.**

**No craftsman/craft
shall be found any more in thee.**

**No sound of a millstone
shall be heard no more at all in thee.**

**No light of a candle
shall shine no more at all in thee.**

**No voice of the bridegroom & bride
shall be heard no more in thee.**

REVELATION 18:

Rev 18:23b-24

23bfor thy merchants were the great men of the earth; for by thy sorceries were all nations deceived.

24 And in **HER** was found the blood of prophets, and of saints, and of all that were slain upon the earth.

Rev 9:21

Neither repented they of their murders, nor of their sorceries, nor of their fornication, nor of their thefts.

G5331

sorceries

φαρμακεία

pharmakeia

far-mak-i'-ah

From **G5332**; medication ("pharmacy"), that is, (by extension) *magic* (literal or figurative): - sorcery, witchcraft.

JUDGMENT OF BABYLON

Thy merchants were the great men of the earth.

For by thy sorceries were all nations deceived.

In HER found:

- **the blood of prophets**
- **the blood of saints**
- **all that were slain on the earth**

GLOBAL RELIGIOUS SYSTEM - False Religions & Apostate Christianity

Rev 17:4-5 ⁴And the woman was arrayed in purple and scarlet colour, and decked with gold and precious stones and pearls, having a golden cup in her hand full of abominations and filthiness of her fornication: ⁵And upon her forehead was a name written, MYSTERY, BABYLON THE GREAT, THE MOTHER OF HARLOTS AND ABOMINATIONS OF THE EARTH.

Rev 18:16 ¹⁶And saying, Alas, alas that great city, that was clothed in fine linen, and purple, and scarlet, and decked with gold, and precious stones, and pearls!

Rev 17:2 ²With whom the kings of the earth have committed fornication, and the inhabitants of the earth have been made drunk with the wine of her fornication.

Rev 18:2 ²And he cried mightily with a strong voice, saying, Great Babylon is fallen, is fallen, and is become the habitation of devils, and the hold of every unclean and hateful bird.

Rev 18:3 ³For all nations have drunk of the wine of her fornication, and the kings of the earth have committed fornication with her,

Rev 18:9 ⁹And the kings of the earth, who have committed fornication and lived deliciously with her, shall bewail her, and lament for her, when they shall see the smoke of her burning,

Rev 18:5 ⁵For her sins have reached unto heaven, and God hath remembered her iniquities.

Rev 18:20 ²⁰Rejoice over her, thou heaven, and ye holy apostles and prophets; for God hath avenged you on her.

Rev 18:24 ²⁴And in her was found the blood of prophets, and of saints, and of all that were slain upon the earth.

Rev 17:6 ⁶And I saw the woman drunken with the blood of the saints, and with the blood of the martyrs of Jesus: and when I saw her, I wondered with great admiration.

BABYLON - SPIRITUAL

Rev 18:4 ⁴And I heard another voice from heaven, saying, Come out of her, my people, that ye be not partakers of her sins, and that ye receive not of her plagues.

**GLOBAL GOVERNMENTAL / POLITICAL SYSTEM -
“kings of the earth”**

Rev 17:2 ² With whom **the kings of the earth** have committed fornication, and the inhabitants of the earth have been made drunk with the wine of her fornication.

Rev 17:12-13 ¹² And **the ten horns which thou sawest are ten kings**, which have received no **kingdom** as yet; but receive power **as kings** one hour with the beast. ¹³ These have one mind, and shall give their power and strength unto the beast.

Rev 17:18 ¹⁸ And the woman which thou sawest is that great city, which **reigneth over the kings of the earth**.

Rev 18:3 ³ For all nations have drunk of the wrath of her fornication, and **the kings of the earth** have committed fornication with her, and the merchants of the earth are waxed rich through the abundance of her delicacies.

Rev 18:9 ⁹ And **the kings of the earth**, who have committed fornication and lived deliciously with her, shall bewail her, and lament for her, when they shall see the smoke of her burning,

**GLOBAL ECONOMICAL / FINANCIAL SYSTEM
“Merchants of the earth” , “rich/riches”**

Rev 18:3and **the merchants of the earth are waxed rich through the abundance of her delicacies**.

Rev 18:11 ¹¹ And **the merchants of the earth shall weep and mourn over her; for no man buyeth their merchandise any more:**

Rev 18:12-14 ¹² **The merchandise** of gold, and silver, and precious stones, and of pearls, and fine linen, and purple, and silk, and scarlet, and all thyine wood, and all manner vessels of ivory, and all manner vessels of most precious brass, and iron, and marble, ¹³ And cinnamon, and balm, and myrrour, and incense, and spices, and ointments, and frankincense, and wine, and oil, and wheat, and beasts, and sheep, and horses, and chariots, and slaves, and souls of men. ¹⁴ And the fruits that thy soul lusted after are departed from thee, and all things which were dainty and goodly are departed from thee, and thou shalt find them no more at all.

Rev 18:15 ¹⁵ **The merchants of these things, which were made rich by her**, shall stand afar off for the fear of her torment, weeping and wailing,

Rev 18:17 ¹⁷ For in one hour **so great riches is come to nought. And every shipmaster, and all the company in ships, and sailors, and as many as trade by sea, stood afar off,**

Rev 18:19 ,.... Alas, alas **that great city, wherein were made rich all that had ships in the sea by reason of her costliness!**

Rev 18:22-23 ²² shall be heard no more at all in thee;, shall be found any more in thee; **for thy merchants were the great men of the earth;** for by thy sorceries were all nations deceived.

BABYLON - PHYSICAL

BABYLON DESTROYED
MADE DESOLATE IN ONE HOUR:

Rev 17:16-17 ¹⁶ And the ten horns which thou sawest upon the beast, these shall hate the whore, and **shall make her desolate and naked, and shall eat her flesh, and burn her with fire.** ¹⁷ For God hath put their hearts to fulfil his will, and to agree, and give their kingdom unto the beast, until the words of God shall be fulfilled.

Rev 18:8 ⁸ Therefore shall her plagues come **in one day, death, and mourning, and famine; and she shall be utterly burned with fire:** for strong is the Lord God who judgeth her.

Rev 18:9 ⁹ And the kings of the earth, who have committed fornication and eaten their flesh with her, **shall bewail her, and lament for her, when they shall see that she is desolate, because they say, Alas, alas, that great city, which was the head of all the earth, because she was made rich by reason of her.**

Rev 18:10 ¹⁰ Standing afar off for the fear of her torment, they shall say, Alas, alas, that great city, which was the head of all the earth, because she was made rich by reason of her, **for in ONE HOUR is thy judgment come.**

Rev 18:11 ¹¹ And the **merchants** that were made rich by her, **shall bewail her, and say, Alas, alas, that great city, which was the head of all the earth, because she was made rich by reason of her; for no man buyeth their merchandise any more:**

Rev 18:15 ¹⁵ The merchants of the earth, who were made rich by her, **shall stand afar off for the fear of her torment, weeping and wailing,**

Rev 18:17-19 ¹⁷ For **in ONE HOUR** shall all these things come to nought. And every shipmaster, and all the company in ships, and sailors, and as many as trade by sea, stood afar off, ¹⁸ And cried when they saw **the smoke of her burning,** saying, What city is like unto this great city! ¹⁹ And they cast dust on their heads, and **cried, weeping and wailing,** saying, Alas, alas that great city, wherein were made rich all that had ships in the sea by reason of her costliness! **for in ONE HOUR is she made desolate.**

Rev 18:21 ²¹ And a mighty angel took up a stone like a great millstone, and cast it into the sea, saying, Thus with violence shall that great city Babylon be thrown down, **and shall be found no more at all.**

**BABYLON – PHYSICAL
Destroyed in 1 HOUR**

How does Revelation 18 fit with Revelation 17?

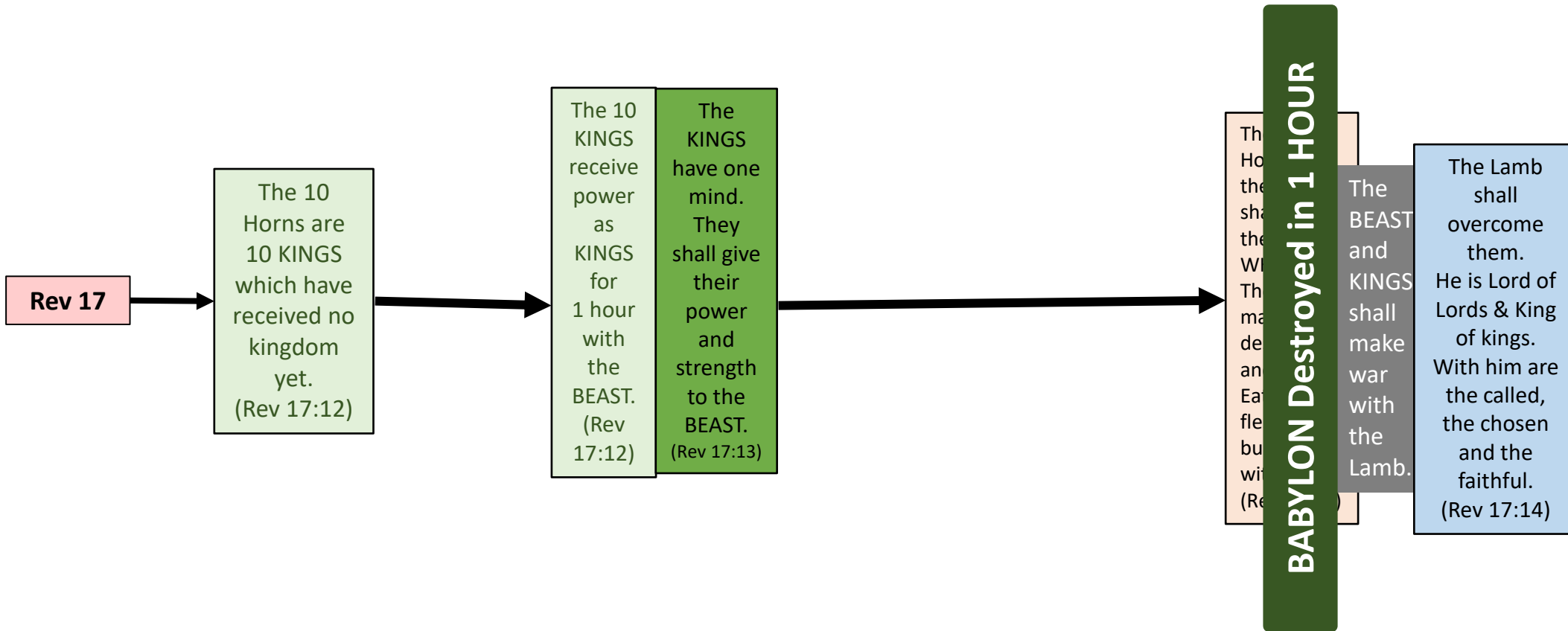

PROPHECY OF BABYLON – Jeremiah 50 & 51 (1)

Jer 50:1

“The word that the Lord spake against **Babylon** and against the land of the Chaldeans **by Jeremiah the prophet.**”

Jeremiah, the prophet, received the prophecy of Babylon.

Jer 50:3

“For **out of the north** there cometh up a nation against her, which shall make **her land desolate, and none shall dwell therein: they shall remove, they shall depart, both man and beast.**”

The nation that will destroy and make Babylon desolate, will come from the north.

Jer 50:41

“Behold, **a people shall come from the north**, and a great nation, and many kings shall be raised up from the coasts of the earth.”

Jer 50:12

“Your mother shall be sore confounded; she that bare you shall be ashamed: behold, **the hindermost of the nations** shall be a wilderness, a dry land, and a desert.”

“Hindermost” means a nation that will come up later in time.

Hindermost - **H319**
 אַחֲרֵיט 'achāriyth *akh-ar-eeth'*
 From H310; the *last* or *end*, hence the *future*; also *posterity*: - (last, latter) end (time), hinder (utter) - most, length, posterity, remnant, residue, reward.

Jer 51:13

¹³ **O thou that dwellest upon many waters**, abundant in treasures, thine end is come, and the measure of thy covetousness.

Rev 17:1b

.....I will shew unto thee the judgment of **the great whore that sitteth upon many waters:**

Rev 17:15

¹⁵ And he saith unto me, **The waters which thou sawest, where the whore sitteth**, are peoples, and multitudes, and nations, and tongues.

PROPHECY OF BABYLON – Jeremiah 50 & 51 (2)

Jer 50:13 “Because of **the wrath of the Lord it shall not be inhabited, but it shall be wholly desolate**: every one that goeth by Babylon shall be astonished, and hiss at all her plagues.”

Jer 50:15 ¹⁵ Shout against her round about: she hath given her hand: her foundations are fallen, her walls are thrown down: **for it is the vengeance of the LORD: take vengeance upon her; as she hath done, do unto her.**

Jer 50:28 ²⁸ The voice of them that flee and escape out of the land of Babylon, to declare in Zion **the vengeance of the LORD our God, the vengeance of his temple.**

Jer 51:6 ⁶ Flee out of the midst of Babylon, and deliver every man his soul: be not cut off in her iniquity; **for this is the time of the LORD's vengeance; he will render unto her a recompence.**

Jer 51:9 ⁹ We would have healed Babylon, but she is not healed: forsake her, and let us go every one into his own country: **for her judgment reacheth unto heaven, and is lifted up even to the skies.**

Jer 51:52 ⁵² Wherefore, behold, **the days come, saith the LORD, that I will do judgment upon her graven images**: and through all her land the wounded shall groan.

Jer 51:56 ⁵⁶ Because the spoiler is come upon her, even upon Babylon, and her mighty men are taken, every one of their bows is broken: **for the LORD God of recompences shall surely requite.**

The wrath of the Lord will be poured upon Babylon and it shall not be inhabited and be desolate.
Vengeance of the LORD.
Time of the LORD's vengeance.
Judgment.
The LORD God of recompences.

Rev 18:5

⁵ For her sins have reached unto heaven, and **God hath remembered her iniquities.**

Rev 18:8

⁸ Therefore shall her plagues come in one day, death, and mourning, and famine; and she shall be utterly burned with fire: **for strong is the Lord God who judgeth her.**

Rev 18:10

¹⁰ Standing afar off for the fear of her torment, saying, **Alas, alas that great city Babylon, that mighty city! for in one hour is thy judgment come.**

PROPHECY OF BABYLON – Jeremiah 50 & 51 (3)

Jer 50:2 ² Declare ye among the nations, and publish, and set up a standard; publish, and conceal not: say, Babylon is taken, Bel is confounded, Merodach is broken in pieces; **her idols are confounded, her images are broken in pieces.**

Jer 50:14 ¹⁴ Put yourselves in array against Babylon round about: all ye that bend the bow, shoot at her, spare no arrows: for **she hath sinned against the LORD.**

Jer 50:24 ²⁴ I have laid a snare for thee, and thou art also taken, O Babylon, and thou wast not aware: thou art found, and also caught, because **thou hast striven against the LORD.**

Jer 50:29 ²⁹ Call together the archers against Babylon: all ye that bend the bow, camp against it round about; let none thereof escape: recompense her according to her work; according to all that she hath done, do unto her: for **she hath been proud against the LORD, against the Holy One of Israel.**

Jer 50:31 ³¹ Behold, I am against thee, **O thou most proud, saith the Lord GOD of hosts:** for thy day is come, the time that I will visit thee.

Jer 50:38 ³⁸ A drought is upon her waters; and they shall be dried up: **for it is the land of graven images, and they are mad upon their idols.**

Jer 51:17 ¹⁷ Every man is brutish by his knowledge; **every founder is confounded by the graven image: for his molten image is falsehood,** and there is no breath in them.

Jer 51:18 ¹⁸ They are vanity, the work of errors: in the time of their visitation they shall perish.

Jer 51:37 ³⁷ And Babylon shall become heaps, **a dwellingplace for dragons,** an astonishment, and an hissing, without an inhabitant.

Jer 51:47 ⁴⁷ Therefore, behold, the days come, that I will do judgment upon **the graven images of Babylon:** and her whole land shall be confounded, and all her slain shall fall in the midst of her.

Jer 51:52 ⁵² Wherefore, behold, the days come, saith the LORD, that I will do judgment upon **her graven images:** and through all her land the wounded shall groan.

Idols and images.
Land of graven images and idols.
Molten image is falsehood.
Dwelling place for dragons.

Rev 18:2

2 And he cried mightily with a strong voice, saying, **Babylon the great is fallen, is fallen,** and is become the habitation of devils, and the hold of every foul spirit, and a cage of every unclean and hateful bird.

Rev 17:1-2 And there came one of the seven angels which had the seven vials, and talked with me, saying unto me, Come hither; I will shew unto thee the judgment of the great whore that sitteth upon many waters: ² With whom the kings of the earth **have committed fornication, and the inhabitants of the earth have been made drunk with the wine of her fornication.**

Sinned against the LORD.
“Striven against the LORD”.
(contested, fought against)
Proud against the LORD.
Vanity (excessive pride in own achievements)

Rev 18:7 ⁷ How much **she hath glorified herself,** and lived deliciously, so much torment and sorrow give her: **for she saith in her heart, I sit a queen,** and am no widow, and shall see no sorrow.

PROPHECY OF BABYLON – Jeremiah 50 & 51 (4)

Jer 50:3 ³ For out of the north there cometh up a nation against her, which **shall make her land desolate, and none shall dwell therein**: they shall remove, they shall depart, both man and beast.

Jer 50:12-13 ¹² Your mother shall be sore confounded; she that bare you shall be ashamed: behold, the hindermost of the nations **shall be a wilderness, a dry land, and a desert**. ¹³ Because of the wrath of the LORD **it shall not be inhabited, but it shall be wholly desolate**: every one that goeth by Babylon shall be astonished, and hiss at all her plagues.

Jer 50:22-23 ²² A sound of battle is in the land, and **of great destruction**. ²³ How is the hammer of the whole earth cut asunder and broken! how is Babylon become **a desolation among the nations!**

Jer 50:26 ²⁶ Come against her from the utmost border, open her storehouses: cast her up as heaps, and **destroy her utterly: let nothing of her be left**.

Jer 50:39-40 ³⁹ Therefore the wild beasts of the desert with the wild beasts of the islands shall dwell there, and the owls shall dwell therein: and **it shall be no more inhabited for ever; neither shall it be dwelt in from generation to generation**. ⁴⁰ As God overthrew Sodom and Gomorrah and the neighbour cities thereof, saith the LORD; **so shall no man abide there, neither shall any son of man dwell therein**.

Jer 50:45 ⁴⁵ Therefore hear ye the counsel of the LORD, that he hath taken against Babylon; and his purposes, that he hath purposed against the land of the Chaldeans: Surely the least of the flock shall draw them out: **surely he shall make their habitation desolate with them**.

Jer 51:2-3 ² And will send unto Babylon fanners, that shall fan her, and **shall empty her land**: for in the day of trouble they shall be against her round about. ³ Against him that bendeth let the archer bend his bow, and against him that lifteth himself up in his brigandine: and spare ye not her young men; **destroy ye utterly all her host**.

Jer 51:8 ⁸ **Babylon is suddenly fallen and destroyed**: howl for her; take balm for her pain, if so be she may be healed.

Jer 51:26 ²⁶ And they shall not take of thee a stone for a corner, nor a stone for foundations; but **thou shalt be desolate for ever**, saith the LORD.

Jer 51:29 ²⁹ And the land shall tremble and sorrow: for every purpose of the LORD shall be performed against Babylon, **to make the land of Babylon a desolation without an inhabitant**.

Jer 51:43 ⁴³ **Her cities are a desolation, a dry land, and a wilderness, a land wherein no man dwelleth**, neither doth any son of man pass thereby.

Jer 51:62 ⁶² Then shalt thou say, O LORD, thou hast spoken against this place, **to cut it off, that none shall remain in it, neither man nor beast, but that it shall be desolate for ever**.

Make land desolate, none shall dwell therein.
Shall be a wilderness, a dry land, a desert. Shall not be inhabited.
Shall be wholly desolate.
Great destruction. A desolation among the nations.
Destroy her utterly. Let nothing of her be left.
Shall be no more inhabited for ever. No man shall abide there.
Shall make their habitation desolate.
Shall empty her land. Destroy utterly.
Is suddenly fallen and destroyed.
Shall be desolate for ever.
Make the land a desolation and without an inhabitant.
Her cities are a desolation, a dry land, a wilderness, a land where no man dwells.
Shall be cut off. None shall remain in it. It shall be desolate for ever.

Rev 18:19saying, Alas, alas that great city, for in one hour is she made desolate.

Rev 18:21Thus with violence shall that great city Babylon be thrown down, and shall be found no more at all.

PROPHECY OF BABYLON – Jeremiah 50 & 51 (5)

Jer 50:14-15 “Put yourselves in array against Babylon round about: all ye that bend the bow, shoot at her, spare no arrows: for **she hath sinned against the Lord.**”

Babylon has sinned against the Lord.

Rev 18:5

⁵ For her sins have reached unto heaven, and God hath remembered her iniquities.

Jer 50:29 “**Call together the archers against Babylon:** all ye that bend the bow, camp against it round about; let none thereof escape: **recompense her according to her work; according to all that she hath done, do unto her:** for she hath been proud against the Lord, against the Holy One of Israel.”

The vengeance of the Lord shall destroy Babylon. She will be recompensed according to her works.

Rev 18:6

⁶ Reward her even as she rewarded you, and double unto her double according to her works: in the cup which she hath filled fill to her double.

Jer 51:7

“Babylon hath been a golden cup in the Lord's hand, that made **all the earth drunken: the nations have drunken of her wine;** therefore the nations are mad.”

All the earth/nations drunk with her wine.

Rev 18:3

³ For all nations have drunk of the wine of the wrath of her fornication, and the kings of the earth have committed fornication with her, and the merchants of the earth are waxed rich through the abundance of her delicacies.

PROPHECY OF BABYLON – Jeremiah 50 & 51 (6)

Jer 51:6

“**Flee out of the midst of Babylon**, and deliver every man his soul: be not cut off in her iniquity; for **this is the time of the Lord's vengeance; he will render unto her a recompence.**”

Jer 51:45

“**My people, go ye out of the midst of her, and deliver ye every man his soul from the fierce anger of the Lord.**”

“Flee out of the midst of
Babylon”
Time for the Lord’s vengeance

Rev 18:4 And I heard another voice from heaven, saying, Come out of her, my people, that ye **be not partakers of her sins**, and that ye **receive not of her plagues.**

Jer 51:7

“Babylon hath been a golden cup in the Lord's hand, that made **all the earth drunken: the nations have drunken of her wine**; therefore the nations are mad.”

All the earth/nations drunk with
her wine.

Rev 18:3

3 For **all nations have drunk of the wine of the wrath of her fornication**, and the **kings of the earth** have committed **fornication with her**, and the **merchants of the earth** are waxed **rich** through the abundance of **her delicacies.**

Jer 50:37 “A sword is upon their horses, and upon their chariots, and upon **all the mingled people that are in the midst of her**; and **they shall become as women**: a sword is upon her treasures; and they shall be robbed.”

Jer 51:30 ³⁰The mighty men of Babylon have forborn to fight, they have remained in their holds: their might hath failed; **they became as women**: they have burned her dwellingplaces; her bars are broken.

“Mingled people” may mean a multi cultural society.
“Shall become as women”?

PROPHECY OF BABYLON – Jeremiah 50 & 51 (7)

How shall Babylon be destroyed?

Jer 51:1 “Thus saith the Lord; Behold, I will raise up against Babylon, and against them that dwell in the midst of them that rise up against me, a destroying wind;”

A ‘destroying wind’ will come against Babylon.

Jer 50:32 ³² And the most proud shall stumble and fall, and none shall raise him up: and **I will kindle a fire in his cities**, and it shall devour all round about him.

‘I will kindle a fire in his cities’

Rev 17:16 ¹⁶ And the ten horns which thou sawest upon the beast, these shall hate the whore, and shall make her desolate and naked, and shall eat her flesh, **and burn her with fire.**

Rev 18:8 ⁸ Therefore shall her plagues come in one day, death, and mourning, and famine; **and she shall be utterly burned with fire:** for strong is the Lord God who judgeth her.

Jer 51:42 “The **sea is come up upon Babylon: she is covered with the multitude of the waves thereof.**”

Babylon ‘submerged’ into the sea.

Rev 18:21 ²¹ And a **mighty angel took up a stone like a great millstone**, and cast it into the sea, saying, **Thus with violence shall that great city Babylon be thrown down, and shall be found no more at all.**

Jer 51:63-64 ⁶³ And it shall be, when thou hast made an end of reading this book, that thou shalt bind a stone to it, and cast it into the midst of Euphrates:

Babylon shall sink.

⁶⁴ And thou shalt say, **Thus shall Babylon sink, and shall not rise from the evil that I will bring upon her:** and they shall be weary. Thus far are the words of Jeremiah.

Rev 18:21 ²¹ And a **mighty angel took up a stone like a great millstone**, and cast it into the sea, saying, **Thus with violence shall that great city Babylon be thrown down, and shall be found no more at all.**

Timeline

Revelation

13, 17, 18

SUMMARY: Rev 13

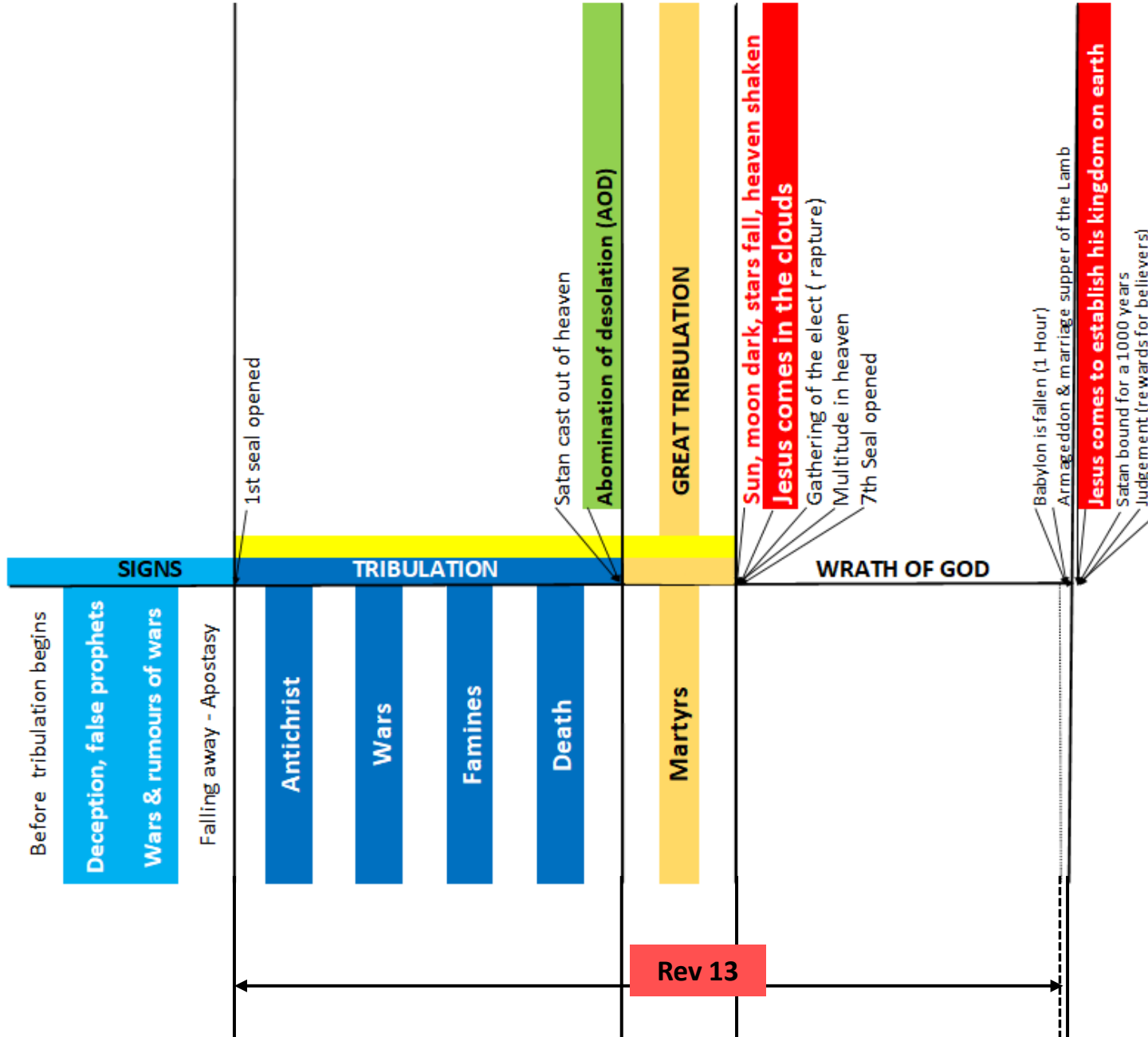

Rev 13

- Antichrist put in power
- Deadly wound
- Blasphemy against God
- Power over the saints
- False prophet
- Mark of the beast

REVELATION 13

SUMMARY: Rev 17

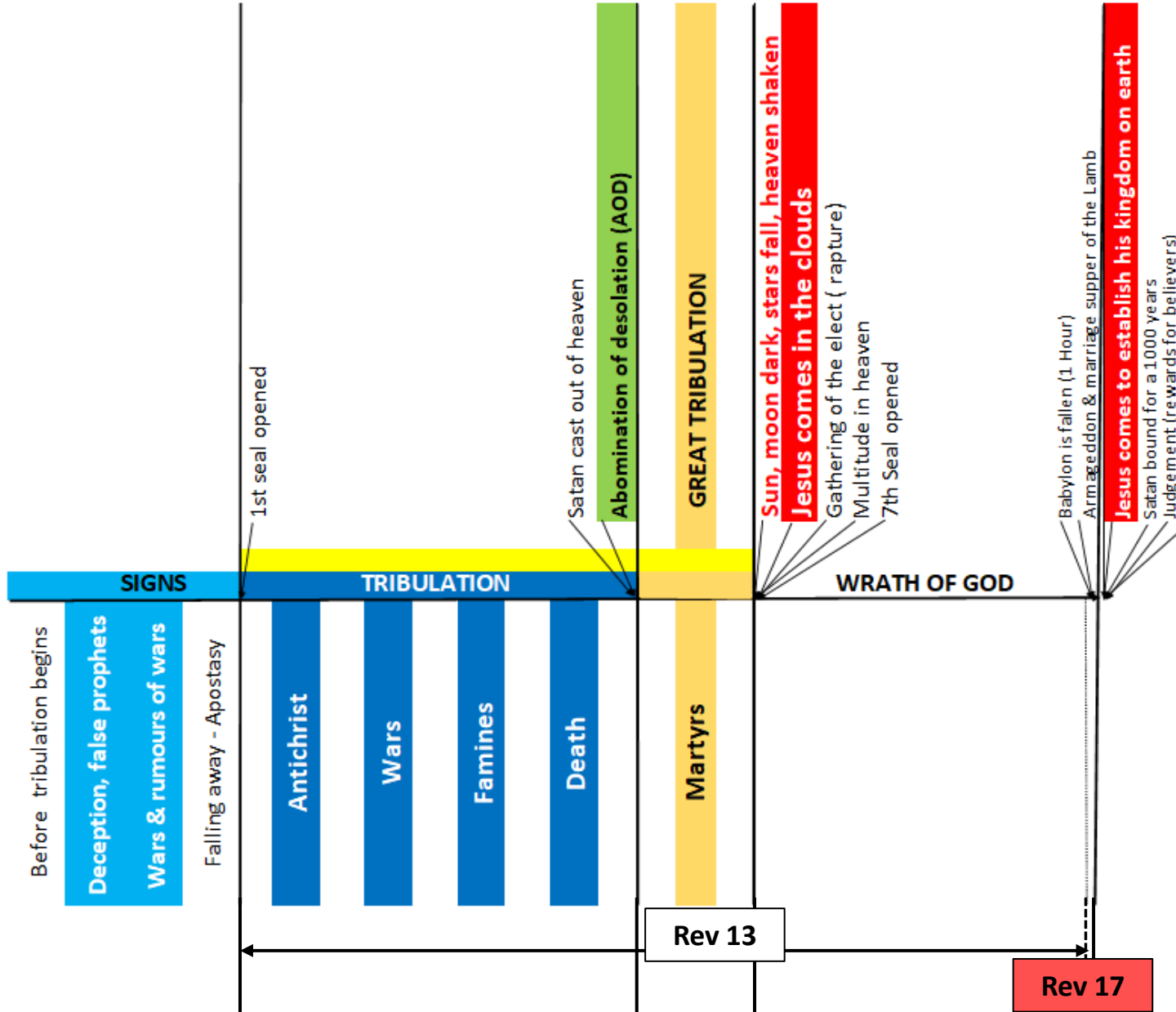

Rev 17

Judgment of the Whore

Details of the great Whore/woman
 Details of the Beast (with 7 heads and 10 horns)

REVELATION 17

SUMMARY: Rev 18

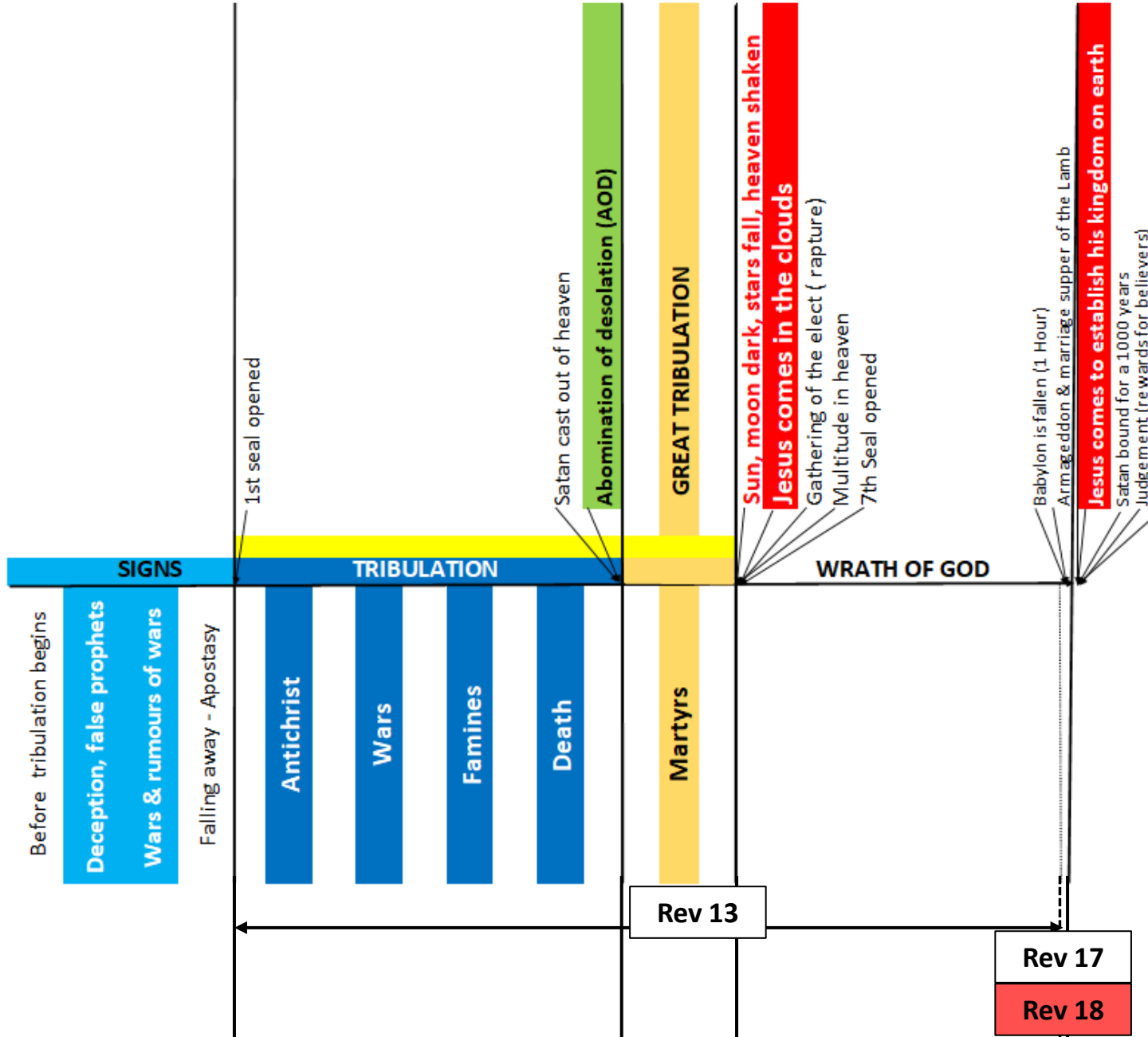

Rev 18

Destruction of Babylon
ONE HOUR

REVELATION 18